



■ vers. 009 - sofa



■ vers. 072 + 399 + 019 - sectional



■ vers. 072 + 399 + 019 - sectional

Surround 2571



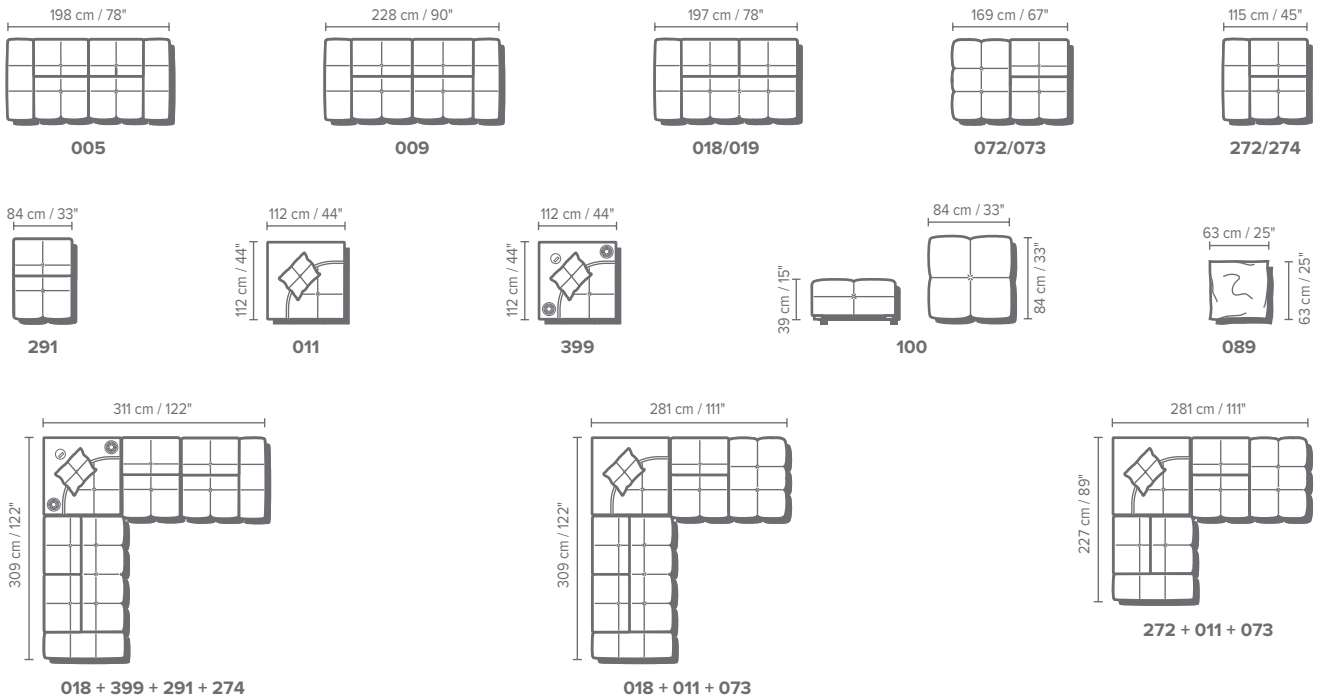

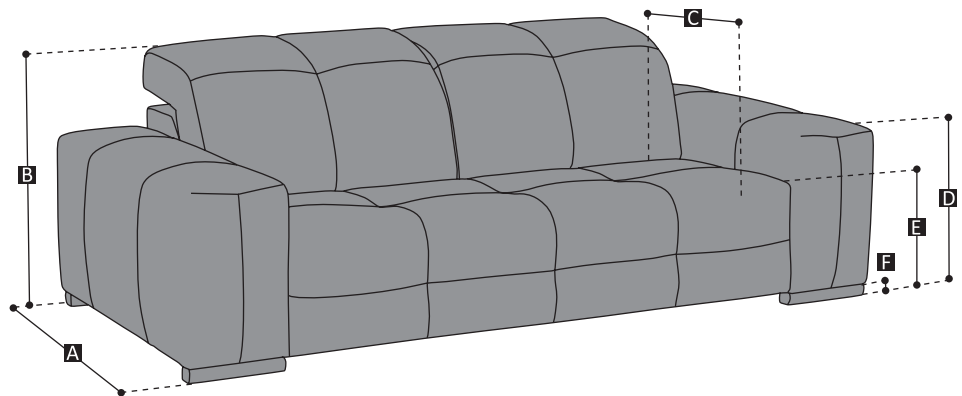

SCHEMATICS



- A = 116 cm / 46" (depth)
- B = 75-101 cm / 30-40" (height)
- C = 62 cm / 24" (seat depth)
- D = 54 cm / 21" (arm height)
- E = 40 cm / 16" (seat height)
- F = 4,5 cm / 2" (leg height)



TECHNICAL FEATURES

	COVERING	Leather <input checked="" type="checkbox"/>	Soft Cover <input type="checkbox"/>	Mix <input type="checkbox"/>		
	LEGS	Plastic <input type="checkbox"/>	Metal <input type="checkbox"/>	Wood <input checked="" type="checkbox"/>	Upholstered <input type="checkbox"/>	
	FILLING	Arms <input checked="" type="checkbox"/> Foam <input type="checkbox"/> Fiber <input type="checkbox"/> Feather	Seat Cushion <input checked="" type="checkbox"/> Foam <input type="checkbox"/> Fiber <input type="checkbox"/> Feather	Back Cushion <input checked="" type="checkbox"/> Foam <input type="checkbox"/> Fiber <input type="checkbox"/> Feather		
	COMFORT	Standard <input checked="" type="checkbox"/>	Feather <input type="checkbox"/>	Firm Comfort (not available for GB) <input type="checkbox"/>		
	FUNCTION	Bed <input type="checkbox"/>	Motion <input type="checkbox"/>	Electric Motion <input type="checkbox"/>	Reclining Chair <input type="checkbox"/>	Reclining Headrest <input checked="" type="checkbox"/>
	OPTION	iPod <input checked="" type="checkbox"/>	Contrast Stitching <input type="checkbox"/>	Contrast Welt <input type="checkbox"/>	Two-Tone <input type="checkbox"/>	Removable <input type="checkbox"/>

Surround V571



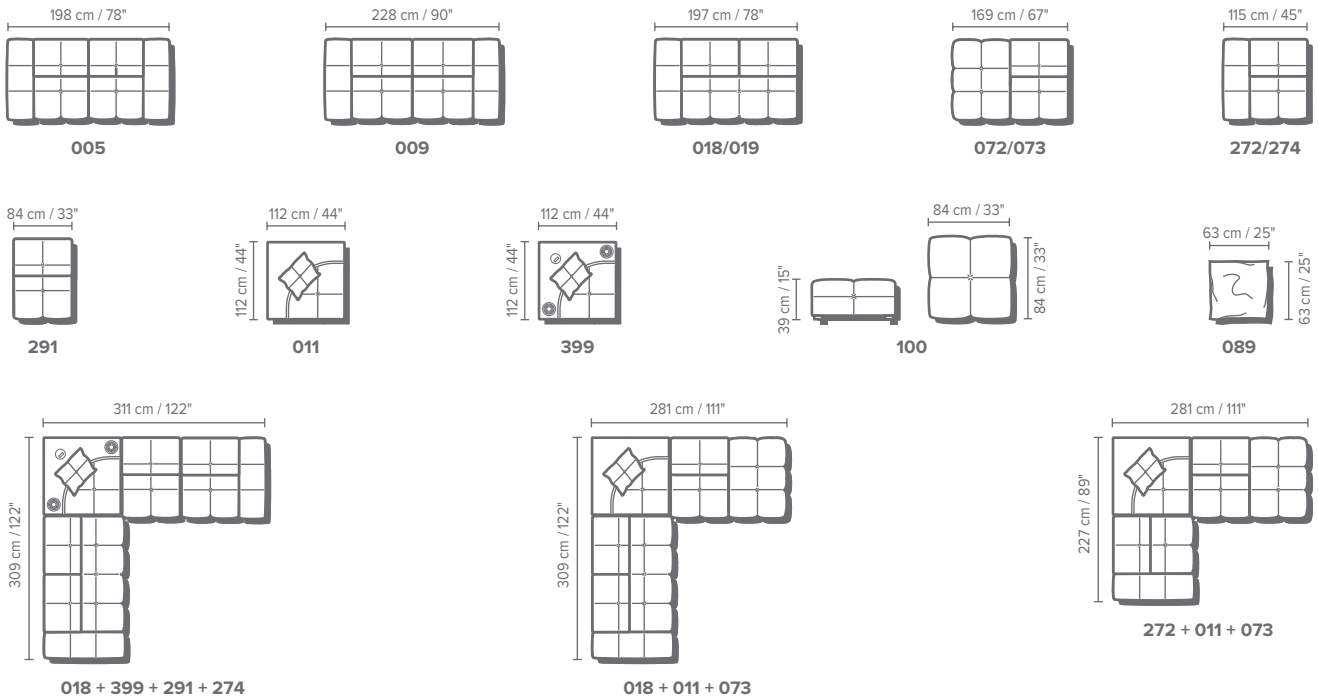

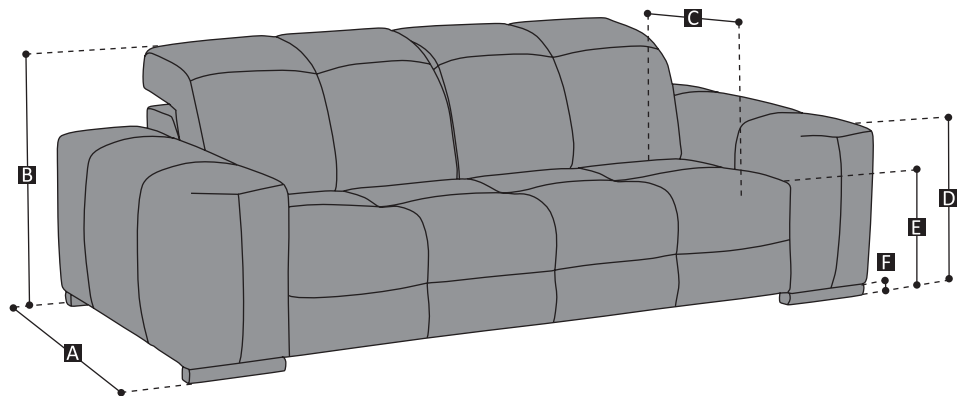

SCHEMATICS



- A = 116 cm / 46" (depth)
- B = 75-101 cm / 30-40" (height)
- C = 62 cm / 24" (seat depth)
- D = 54 cm / 21" (arm height)
- E = 40 cm / 16" (seat height)
- F = 4,5 cm / 2" (leg height)



TECHNICAL FEATURES

	COVERING	Leather <input checked="" type="checkbox"/>	Soft Cover <input type="checkbox"/>	Mix <input type="checkbox"/>		
	LEGS	Plastic <input type="checkbox"/>	Metal <input type="checkbox"/>	Wood <input checked="" type="checkbox"/>	Upholstered <input type="checkbox"/>	
	FILLING	Arms <input checked="" type="checkbox"/> Foam <input type="checkbox"/> Fiber <input type="checkbox"/> Feather	Seat Cushion <input checked="" type="checkbox"/> Foam <input type="checkbox"/> Fiber <input type="checkbox"/> Feather	Back Cushion <input checked="" type="checkbox"/> Foam <input type="checkbox"/> Fiber <input type="checkbox"/> Feather		
	COMFORT	Standard <input checked="" type="checkbox"/>	Feather <input type="checkbox"/>	Firm Comfort (not available for GB) <input type="checkbox"/>		
	FUNCTION	Bed <input type="checkbox"/>	Motion <input type="checkbox"/>	Electric Motion <input type="checkbox"/>	Reclining Chair <input type="checkbox"/>	Reclining Headrest <input checked="" type="checkbox"/>
	OPTION FEATURE	iPod <input checked="" type="checkbox"/>	Contrast Stitching <input checked="" type="checkbox"/>	Contrast Welt <input type="checkbox"/>	Two-Tone <input type="checkbox"/>	Removable <input type="checkbox"/>