



■ vers. 231 - slipper chair



■ vers. 231 + 010 - slipper chair and ottoman



■ vers. 231 + 010 - slipper chair and ottoman

Herb 2426



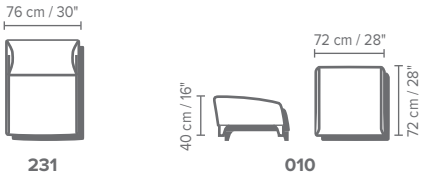

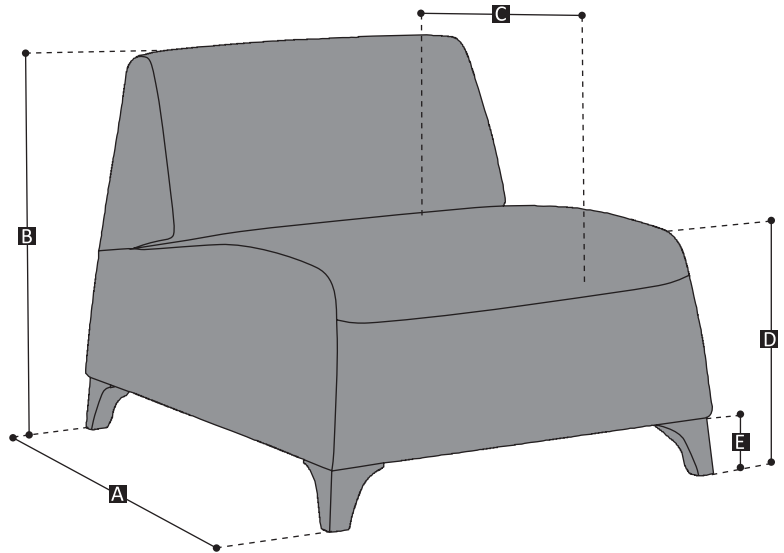

SCHEMATICS



- A = 101 cm / 40" (depth)
- B = 74 cm / 29" (height)
- C = 64 cm / 25" (seat depth)
- D = 45 cm / 18" (seat height)
- E = 10 cm / 4" (legs height)



TECHNICAL FEATURES

	COVERING	Leather <input checked="" type="checkbox"/>	Soft Cover <input checked="" type="checkbox"/>			Mix <input type="checkbox"/>
	LEGS	Plastic <input type="checkbox"/>	Metal <input checked="" type="checkbox"/>	Wood <input checked="" type="checkbox"/>	Upholstered <input type="checkbox"/>	
	FILLING	Arms <input type="checkbox"/> Foam <input type="checkbox"/> Fiber <input type="checkbox"/> Feather	Seat Cushion <input checked="" type="checkbox"/> Foam <input type="checkbox"/> Fiber <input type="checkbox"/> Feather	Back Cushion <input checked="" type="checkbox"/> Foam <input type="checkbox"/> Fiber <input type="checkbox"/> Feather		
	COMFORT	Standard <input checked="" type="checkbox"/>	Feather <input type="checkbox"/>	Firm Comfort (not available for GB) <input type="checkbox"/>		
	FUNCTION	Bed <input type="checkbox"/>	Motion <input type="checkbox"/>	Electric Motion <input type="checkbox"/>	Reclining Chair <input type="checkbox"/>	Reclining Headrest <input type="checkbox"/>
	OPTION	Nails <input type="checkbox"/>	Contrast Stitching <input type="checkbox"/>	Contrast Welt <input type="checkbox"/>	Two-Tone <input type="checkbox"/>	Removable <input type="checkbox"/>