



■ vers. 018 + 019 - sectional



■ vers. 016 + 463 + 017 - sectional



■ vers. 212 + 438 + 438 + 016 + 001 + 463 - sectional

Fashion 2467

SCHEMATICS

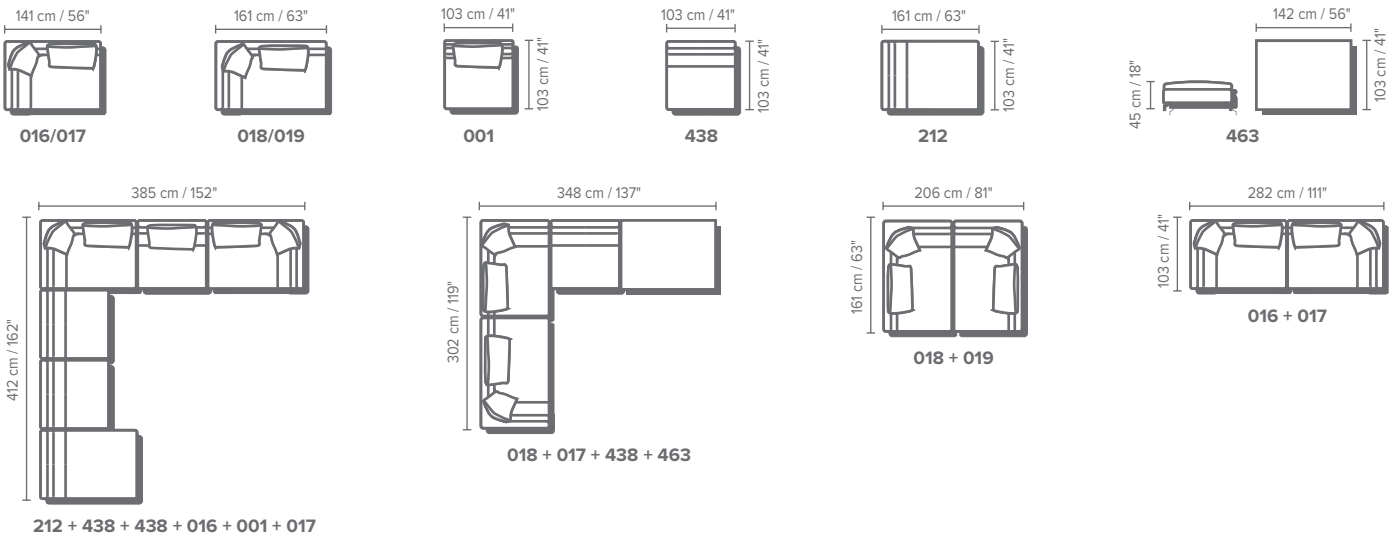

vers. 016/017 - 018/019

- A = 103 cm / 41" (depth)
- B = 90 cm / 35" (height)
- C = 67 cm / 26" (seat depth)
- D = 75 cm / 30" (arm height)
- E = 45 cm / 18" (seat height)
- F = 12 cm / 5" (leg height)

vers. 001

- A = 103 cm / 41" (depth)
- B = 90 cm / 35" (height)
- C = 67 cm / 26" (seat depth)
- E = 45 cm / 18" (seat height)
- F = 12 cm / 5" (leg height)

vers. 438





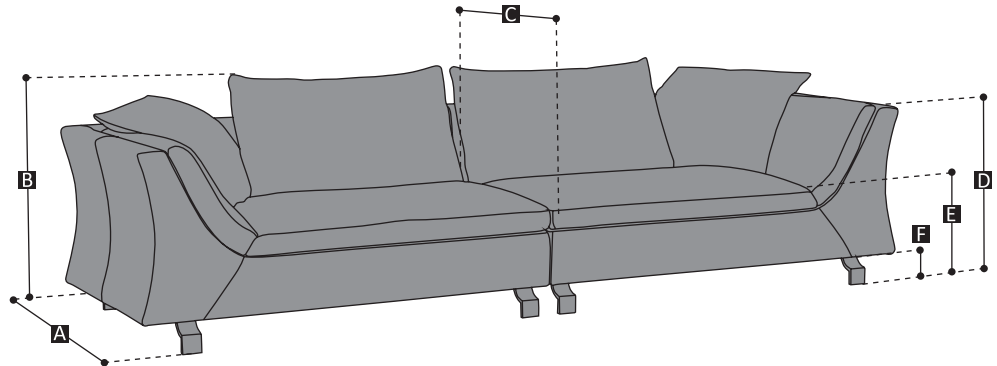

- A = 103 cm / 41" (depth)
- B = 75 cm / 30" (height)
- C = 61 cm / 24" (seat depth)
- E = 45 cm / 18" (seat height)
- F = 12 cm / 5" (leg height)

vers. 212

- A = 161 cm / 63" (depth)
- B = 75 cm / 30" (height)
- C = 119 cm / 47" (seat depth)
- E = 45 cm / 18" (seat height)
- F = 12 cm / 5" (leg height)



TECHNICAL FEATURES

	COVERING	Leather <input checked="" type="checkbox"/>	Soft Cover <input checked="" type="checkbox"/>	Mix <input checked="" type="checkbox"/>		
	LEGS	Plastic <input type="checkbox"/>	Metal <input checked="" type="checkbox"/>	Wood <input type="checkbox"/>	Upholstered <input type="checkbox"/>	
	FILLING	Arms <input checked="" type="checkbox"/> Foam <input type="checkbox"/> Fiber <input checked="" type="checkbox"/> Feather	Seat Cushion <input checked="" type="checkbox"/> Foam <input type="checkbox"/> Fiber <input checked="" type="checkbox"/> Feather	Back Cushion <input checked="" type="checkbox"/> Foam <input type="checkbox"/> Fiber <input checked="" type="checkbox"/> Feather		
	COMFORT	Standard <input type="checkbox"/>	Feather <input checked="" type="checkbox"/>	Firm Comfort (not available for GB) <input type="checkbox"/>		
	FUNCTION	Bed <input type="checkbox"/>	Motion <input type="checkbox"/>	Electric Motion <input type="checkbox"/>	Reclining Chair <input type="checkbox"/>	Reclining Headrest <input type="checkbox"/>
	OPTION	Nails <input type="checkbox"/>	Contrast Stitching <input type="checkbox"/>	Contrast Welt <input type="checkbox"/>	Two-Tone <input checked="" type="checkbox"/>	Removable <input type="checkbox"/>