



■ vers. 000 + 001 + 002 - sectional



■ vers. 000 + 001 + 002 - sectional



■ vers. 003 - armchair



■ vers. 000 + 001 + 002 - sectional



■ vers. 000 + 001 + 011 + 001 + 001 + 100 + 112 - sectional and pillow



■ vers. 000 + 001 + 011 + 001 + 001 + 100 + 112 - sectional and pillow

Cambrè 2638



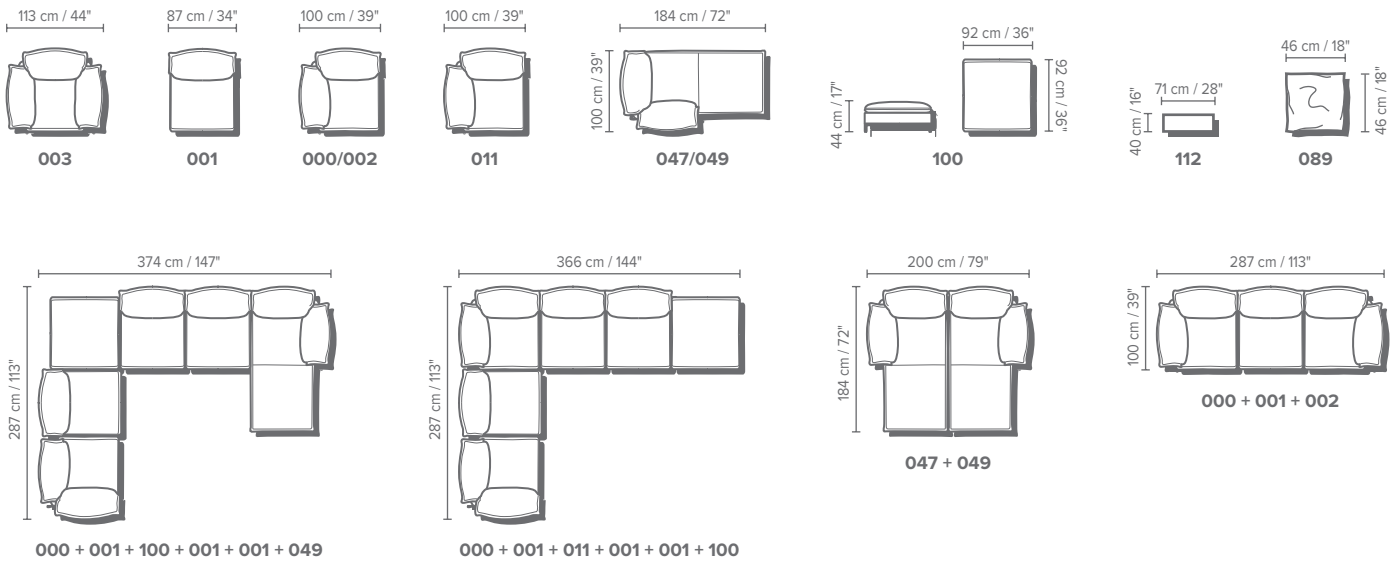

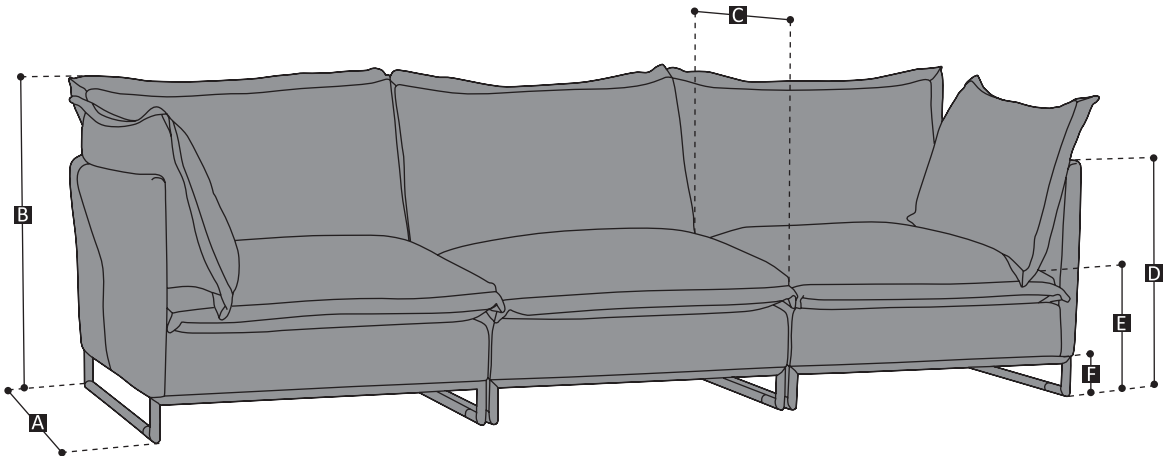

SCHEMATICS



- A = 100 cm / 39" (depth)
- B = 83 cm / 33" (height)
- C = 64 cm / 25" (seat depth)
- D = 68 cm / 27" (arm height)
- E = 44 cm / 17" (seat height)
- F = 12,5 cm / 5" (base height)



TECHNICAL FEATURES

	COVERING	Leather <input checked="" type="checkbox"/>	Soft Cover <input type="checkbox"/>	Mix <input checked="" type="checkbox"/>		
	LEGS	Plastic <input type="checkbox"/>	Metal <input checked="" type="checkbox"/>	Wood <input type="checkbox"/>	Upholstered <input type="checkbox"/>	
	FILLING	Arms: <input type="checkbox"/> Foam, <input type="checkbox"/> Fiber, <input checked="" type="checkbox"/> Feather	Seat Cushion: <input checked="" type="checkbox"/> Foam, <input type="checkbox"/> Fiber, <input checked="" type="checkbox"/> Feather	Back Cushion: <input checked="" type="checkbox"/> Foam, <input type="checkbox"/> Fiber, <input checked="" type="checkbox"/> Feather		
	COMFORT	Standard <input type="checkbox"/>	Feather <input checked="" type="checkbox"/>	Firm Comfort (not available for GB) <input type="checkbox"/>		
	FUNCTION	Bed <input type="checkbox"/>	Motion <input type="checkbox"/>	Electric Motion <input type="checkbox"/>	Reclining Chair <input type="checkbox"/>	Reclining Headrest <input type="checkbox"/>
	OPTION	Feather <input type="checkbox"/>	Contrast Stitching <input type="checkbox"/>	Contrast Welt <input type="checkbox"/>	Two-Tone <input type="checkbox"/>	Removable <input type="checkbox"/>

Cambrè R638



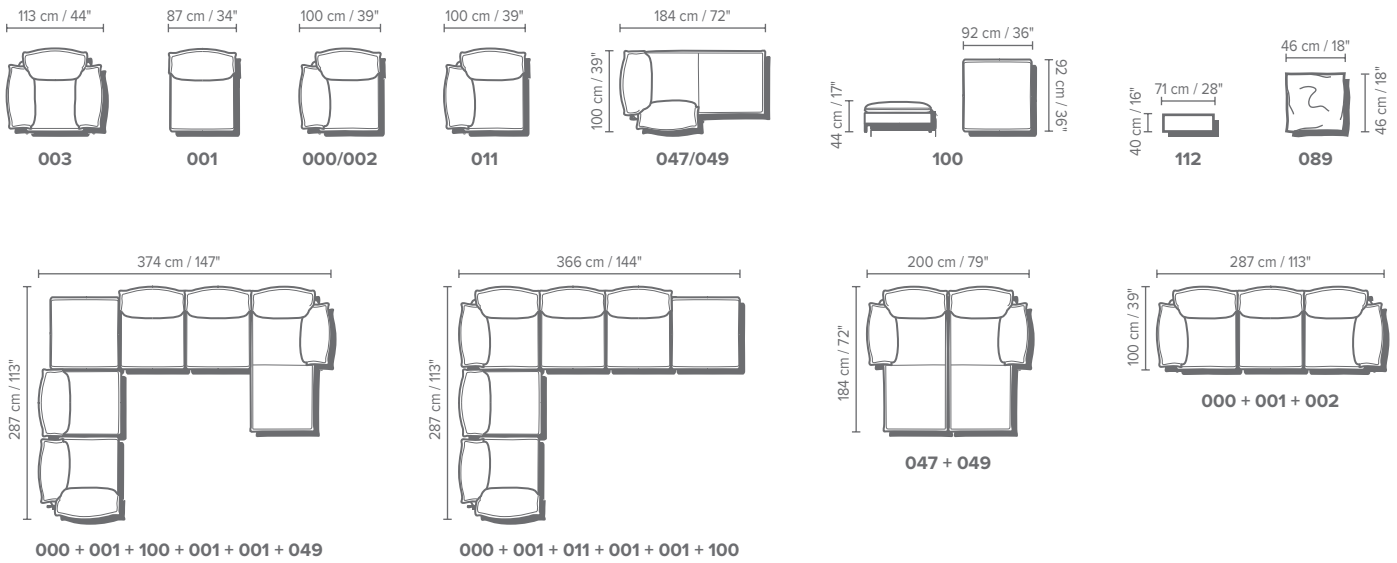

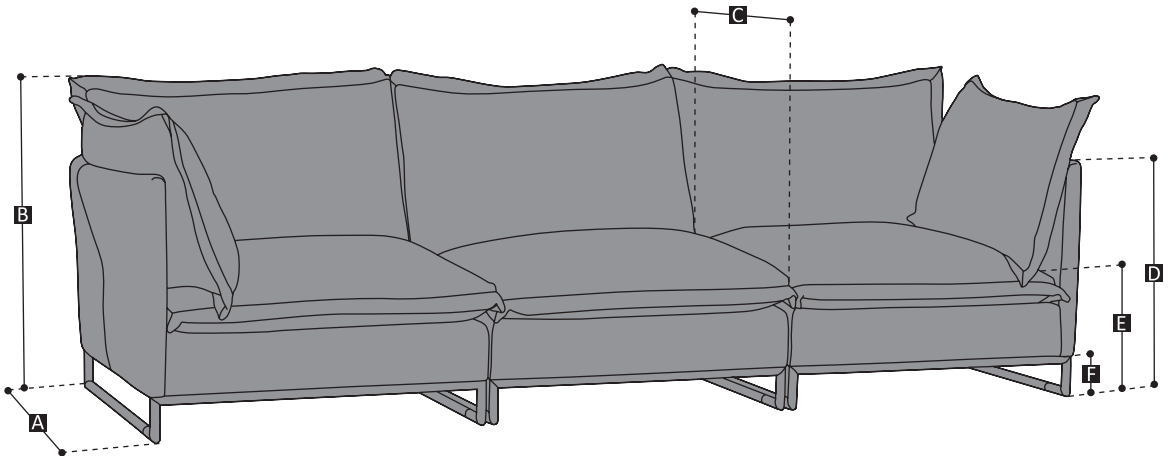

SCHEMATICS



- A = 100 cm / 39" (depth)
- B = 83 cm / 33" (height)
- C = 64 cm / 25" (seat depth)
- D = 68 cm / 27" (arm height)
- E = 44 cm / 17" (seat height)
- F = 12,5 cm / 5" (base height)



TECHNICAL FEATURES

	COVERING	Leather <input type="checkbox"/>	Soft Cover <input checked="" type="checkbox"/>	Mix <input type="checkbox"/>		
	LEGS	Plastic <input type="checkbox"/>	Metal <input checked="" type="checkbox"/>	Wood <input type="checkbox"/>	Upholstered <input type="checkbox"/>	
	FILLING	Arms <input type="checkbox"/> Foam <input type="checkbox"/> Fiber <input checked="" type="checkbox"/> Feather	Seat Cushion <input checked="" type="checkbox"/> Foam <input type="checkbox"/> Fiber <input checked="" type="checkbox"/> Feather	Back Cushion <input checked="" type="checkbox"/> Foam <input type="checkbox"/> Fiber <input checked="" type="checkbox"/> Feather		
	COMFORT	Standard <input type="checkbox"/>	Feather <input checked="" type="checkbox"/>	Firm Comfort (not available for GB) <input type="checkbox"/>		
	FUNCTION	Bed <input type="checkbox"/>	Motion <input type="checkbox"/>	Electric Motion <input type="checkbox"/>	Reclining Chair <input type="checkbox"/>	Reclining Headrest <input type="checkbox"/>
	OPTION FEATURE	Feather <input type="checkbox"/>	Contrast Stitching <input type="checkbox"/>	Contrast Welt <input type="checkbox"/>	Two-Tone <input checked="" type="checkbox"/>	Removable <input checked="" type="checkbox"/>